

SHIM ADJUSTMENT SCREW
 M2 HEX SOCKET HEAD CAP(3x120°)
 シム調整用ねじ
 M2六角穴付きボルト(3x120°)

CAMERA POSITION ADJUSTING SCREW
 M3 HEX SOCKET SET SCREW(3x120°)
 カメラ位置調整ねじ
 M3六角穴付き止めねじ(3x120°)

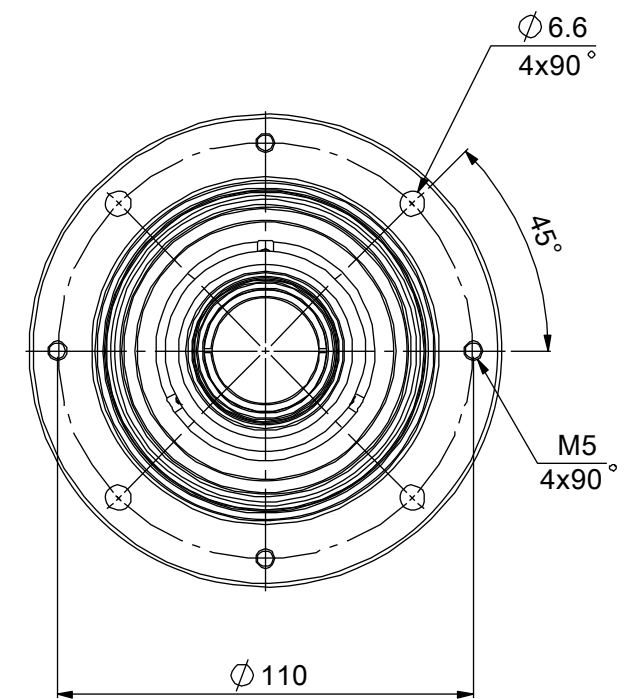

MOUNTING PORTION
DETAIL VIEW

フランジ取付部詳細

MAGNIFICATION : 0.26x
 光学倍率 : 0.26x